

UNIT-5**Wireless LAN Architecture:****Local area network (LAN):**

- A set of computers, computational systems, units, and devices, for example, mobile phones, printers, laptops, smart sensors, and smart labels, networked using a standard suite of protocols
- Local refers to some defined area or a set of nearby or distant stations.

Wireless LAN (WLAN)

- **Also called WiFi (Wireless fidelity)**
- IEEE 802.11a, 802.11b, ... 802.11g standards recommended for WLAN in mobile communication and for establishing communication between mobile devices and Internet or other networks.
-

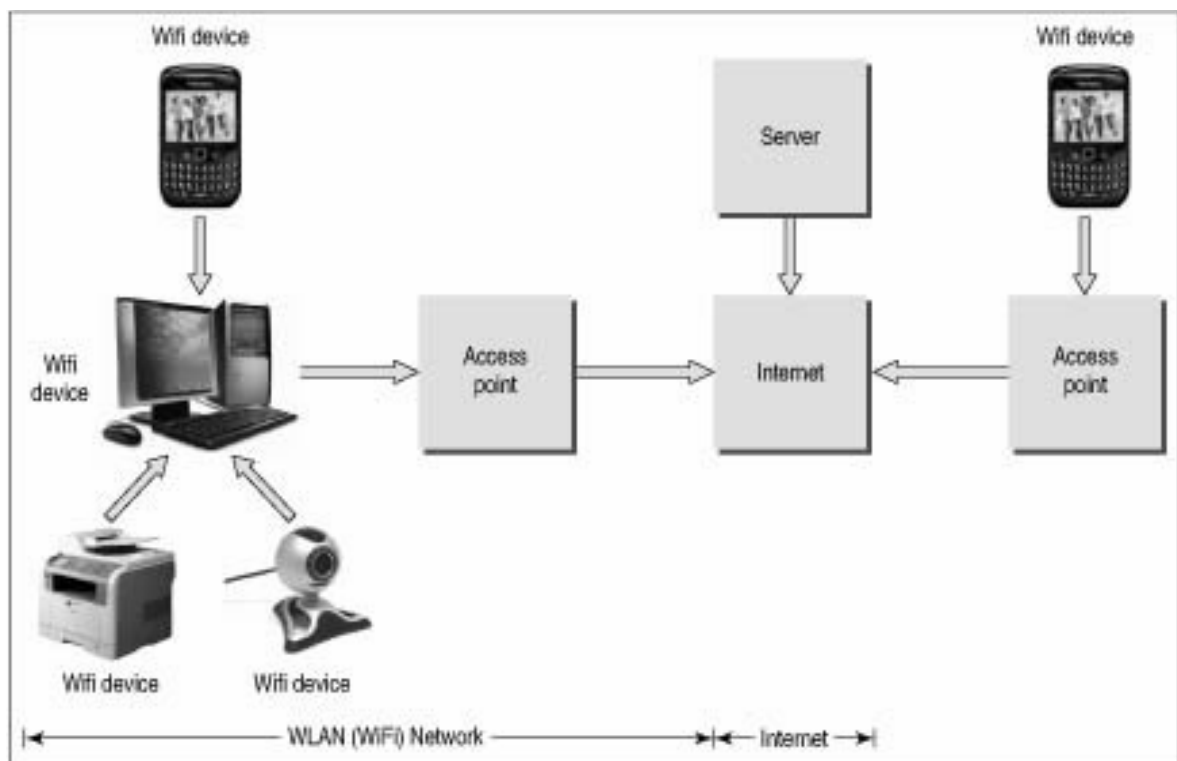

Figure 12.1 WLAN network connected to the Internet and remote the enterprise server

- **Wireless LAN Architecture:**
- **Two service sets in the WLAN architecture**

- Basic Service set (BSS)— Set A has nodes which connect to an access-point
- Independent basic service set (IBSS)— Set B do not connect to any access-point
- IBSSs do not connect among themselves

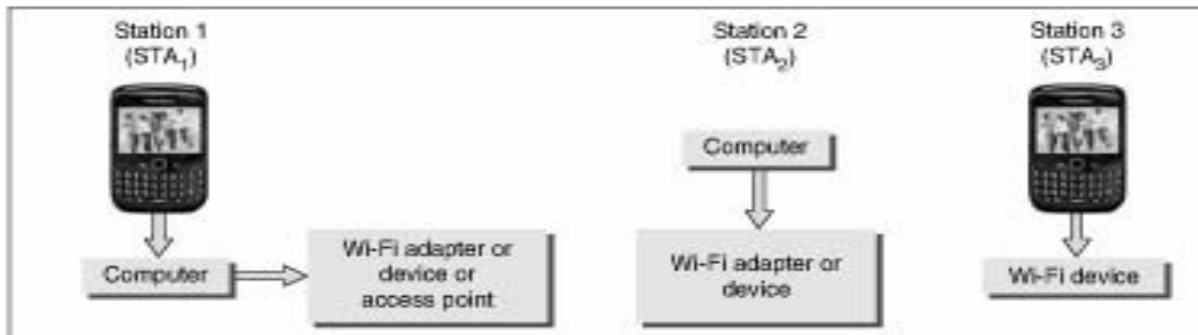

Figure 12.2 WLAN network stations

BSS: Basic Service set (BSS) A

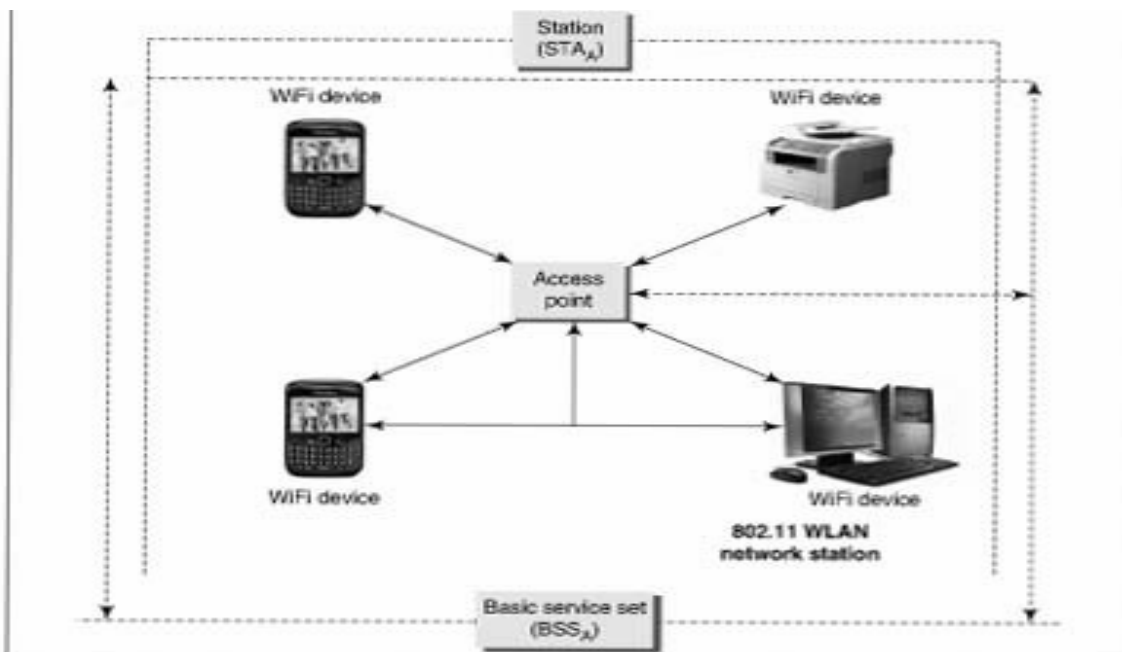

Figure 12.3 BSS which also has an access-point for connectivity to a distribution system or extended service set

- BSS devices in each set interconnect to the access-point using 802.11
- Form a single station STA_A of WLAN using same frequencies for radio

- The BSS station interconnects to other stations through access-points

IBSS Set B

- Set *B* has several stations STA_B , STA_C ,
- WLAN Supports both access-point-based fixed infrastructure WLAN network using BSSs
- Ad-hoc peer-to-peer data routing network using IBSS stations
- A mobile phone, TV with a set-up box, security system, and computer at home
- Form a WLAN station and can use the same frequency band for radio
- Since it does not have an access-point to a distribution system or ESS, the station is a part of an IBSS
- These devices can also have Bluetooth OBEX exchange between mobile phone and computer
- **Node in WLAN**
- Each node of a station uses the same frequency band if it is at a distance from another station or a distinct frequency band if it is not distant enough from another station

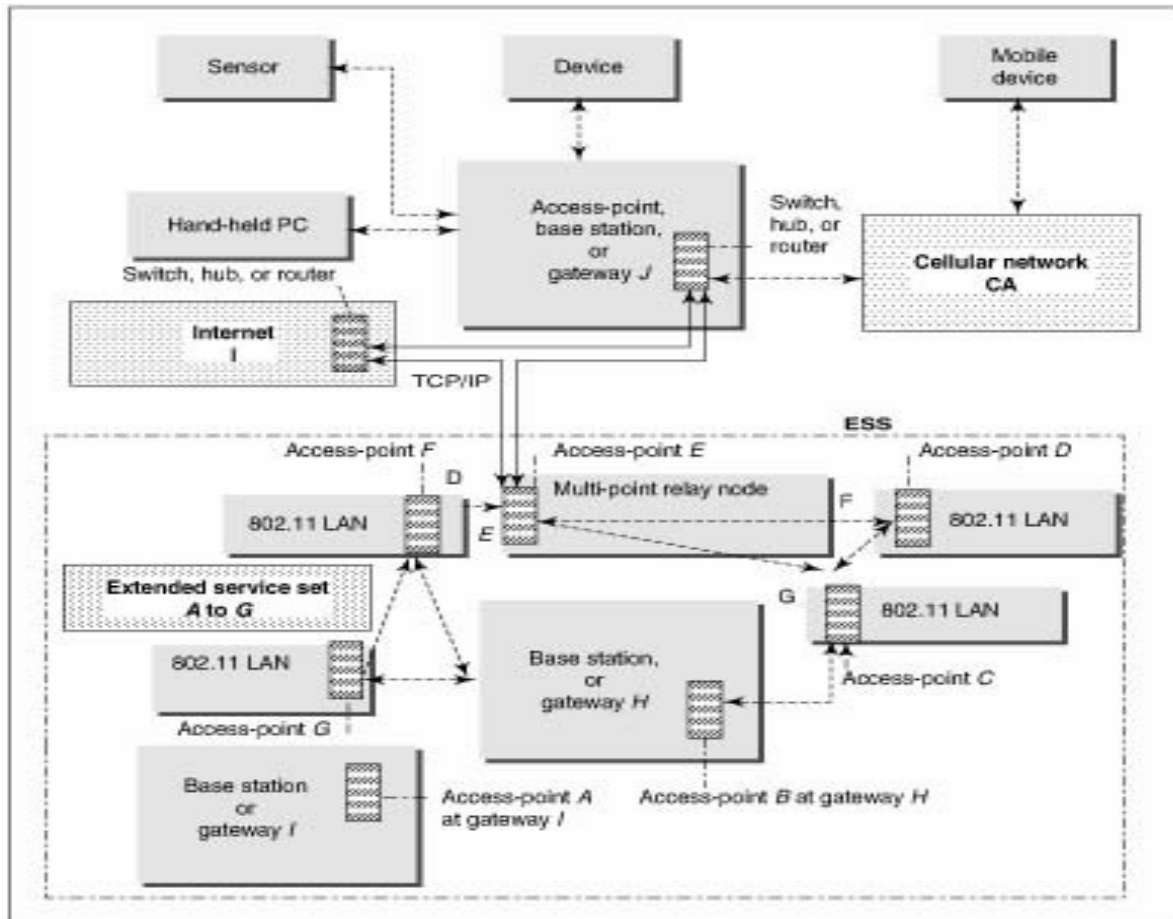

Figure 12.6 802.11 LAN access points of the distribution systems networked together using ESS

- Node at a station can communicate directly to an access-point (in BSS)
- To another node at another station through the access-point
- Communicate among themselves after forming an ad-hoc or any other type of network (for example, Bluetooth) using same frequency band for each node.

Distributed Systems:

- The wireless BSS may or may not provide sufficient coverage.
- **Functions :**
- Perform address to destination mapping.
- Seamless integration of multiple mobile devices in the BSS.

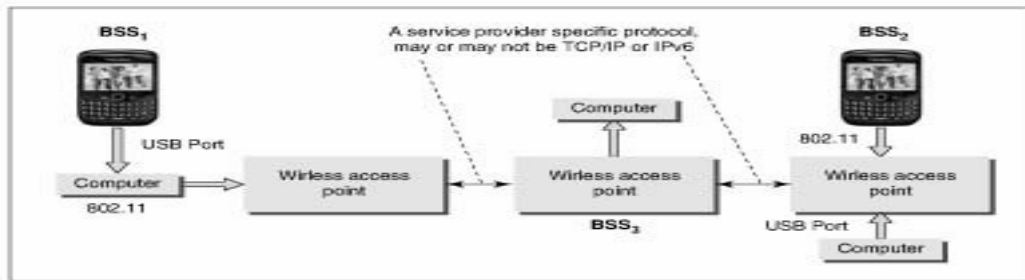
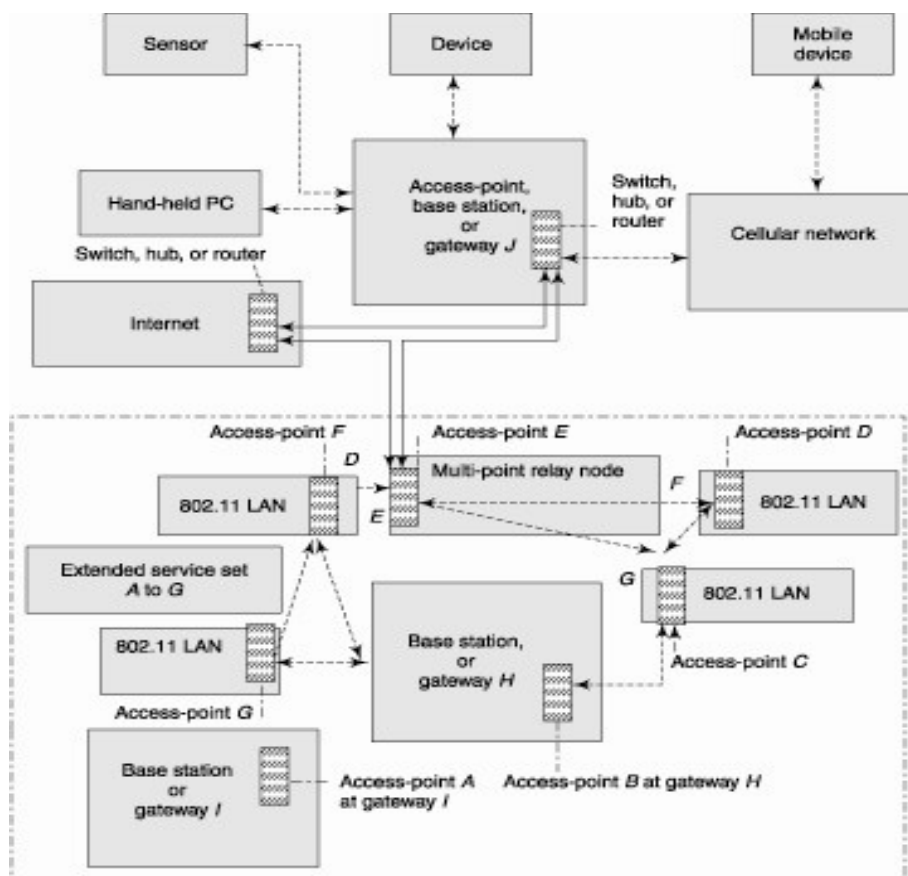

Figure 12.5 Distributed systems interconnected by wireless access points

•

Extended Service Set (ESS):

- Functions as a distribution system possessing an ID, called ESSID
- The 802.11 provides the definition for ESSID, but the distribution system network protocols are not defined within 802.11
- Internet can be deployed by WLAN distribution system.
- Access-points exist at the base stations or gateways J and H
- An access-point also present at a multi-point relay node, E



•

Wireless LAN Protocol layers (IEEE 802.11):

- Each layer has specific protocols to send the bits to next layer
- Open System interconnection (OSI) model Physical (layer 1) layer
- Data link (layer 2)
- Network (layer 3)
- Transport (layer 4)
- Session (layer 5)
- Presentation (layer 6)
- Application (layer 7) layer
- Reception In the order—layer 1 to layer 7
- Transmission in the reverse order—layer 7 to layer 1
- Each layer adds additional headers (messages) in specific formats so that at the receiver, these headers are stripped and the actions and operations specified by the header fields take place
- May not have all the 7 layers
- Some layers functions may be assigned the functions of the neighbouring layer(s)
- The functions of a layer can also be divided amongst sublayers
- **IEEE 802.x set of protocols defined for networking**
- **802.1** [$x = 1$] gives specifications for bridging of sublayers LLC (logic link control) and MAC (medium access control)
- For management of layers 1 and 2
- $x = 2$ gives specifications for LLC sub-layer at layer 2
- $x = 1$ and 2 specifications common to all standards in 802.x for $x = 3$ and above
- $x = 3$ gives the specifications for MAC sub-layer of layer 2 and physical layer for wired LAN, called Ethernet
- Upper layers common in protocols 802.x
- $x = 10$ gives the security specifications for layers 2 and above and is common in protocols 802.1y
- $x=l; y = 1$ means 802.11
- $x=l; y = 5$ means 802.15
- $x=l; y = 6$ means 802.16

802.11 standard— a suite of WLAN protocols:

- For the MAC sub-layer of layer 2 and physical layer (layer 1), which includes security 802.10 specifications

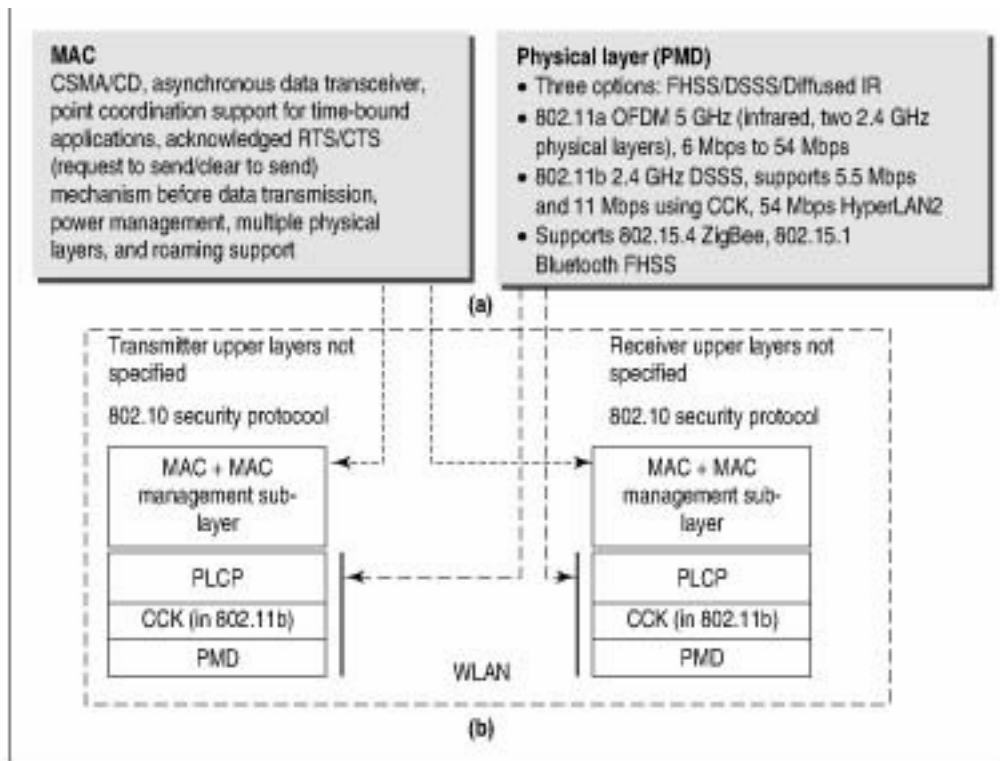

Figure 12.7 (a) Functions of MAC and physical layer (b) Basic protocols layers in 802.11 in receiver and transmitter

Physical layer:

- The layer which transmits or receives the signals through wireless communication or through wire, fiber, or microwave after formatting or multiplexing

Physical layer (PMD)

- Three options: FHSS/DSSS/Diffused IR
- 802.11a OFDM 5 GHz (infrared, two 2.4 GHz physical layers), 6 Mbps to 54 Mbps
- 802.11b 2.4 GHz DSSS, supports 5.5 Mbps and 11 Mbps using CCK, 54 Mbps HyperLAN2
- Supports 802.15.4 ZigBee, 802.15.1 Bluetooth FHSS

MAC

CSMA/CD, asynchronous data transceiver, point coordination support for time-bound applications, acknowledged RTS/CTS (request to send/clear to send) mechanism before data transmission, power management, multiple physical layers, and roaming support

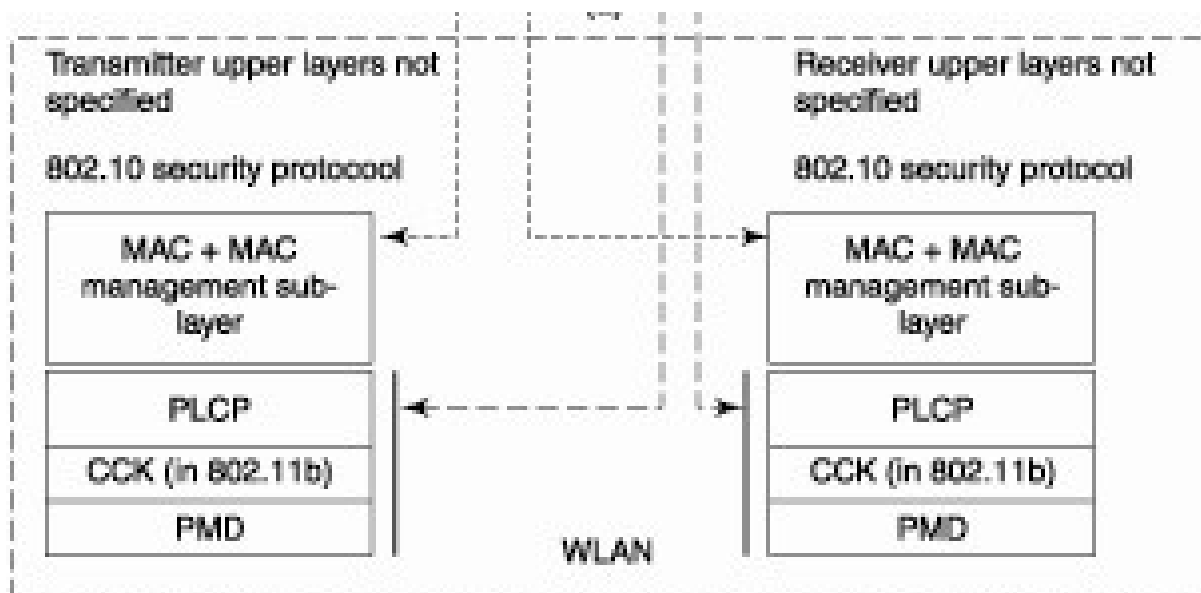
Basic protocols layers in IEEE 802.11:**Physical layer two sub-layers**

- PMD (physical medium dependent) sub-layer
- PLCP (physical layer convergence protocol) sub-layer
- There is an additional sub-layer in 802.11b—CCK (complementary code keying) for data rates of 5.5 Mbps by QPSK to map 4 bits and 11 Mbps 8-QPSK to map 8 bits simultaneously

PMD protocol:

- Specifications of the modulation and coding methods
- Service access-point with 1 Mbps or 2 Mbps data rate to MAC layer
- FHSS—radiated at 10 mW, 100 mW, and 1 W as per country-specific restrictions

- Modulation 1 Mbps Gaussian BPSK or 2 Mbps Gaussian QPSK
- **DSSS**—using 11-bit Barker code radiated at 10 mW, 100 mW, and 1 W as per country-specific restrictions and 1 Mbps or 2 Mbps data rates (symbol rates)
- DSSS transmission characteristics—negligible interference and multi-path delay spread
- Modulation—DQPSK, 11-bit code—11 Mchip/s, Scrambling done by a polynomial $G_Q = z^7 + z^4 + 1$
- **PPM** (Pulse Position Modulation)—a modulation method. 16-PPM is used for 1 Mbps and 4-PPM for 2 Mbps data rate
- 16-PPM means that a code is transmitted for each quad of 4 bits and is positioned in one of the 16 slots (a slot is a 16-bit long sequence of bits, each slot-bit separated by 250 ns)
- PPM method involves 250 ns pulses of diffused infrared (IR) for 10 m range within a room
- IR does not pass through walls and thus provides isolation from neighbouring room nodes

PLCP Sub-layer

- Specifies sensing of the carrier at the receiver and packet formation at the transmitter
- The different transmission and reception protocols (FHSS, DSSS, and diffused IR) specified for the PMD
- Thus a convergence protocol sub-layer required in between the PMD and MAC sub-layers
- PLCP sub-layer protocol prescribes the standard procedure for convergence of PMD to MAC at receiver and from MAC to PMD at transmitter

MAC and MAC Management sub layers

- MAC sub-layer specifies CSMA/CD (CSMA/Collision Detect), RTS/CTS, and PCF mechanisms
- Sub-layer specifies MAC management
- CSMA/CD
- Point coordination support for time-bound applications
- Acknowledged RTS/CTS (request to send/clear to send) mechanism before the data transmission.

Functions of MAC management sub-layer

- **1. Roaming management**
- The access-point registers or deregisters the devices after the scanning
- New device registration provisions for device association at new access-point when it roams into the new area from another access-point area

- **2.Internal receiver clocks are synchronized**, which is necessary
- Generation of beacon signals is also part of management functions.
- A BSS periodically sends beacon signals, which contain—(i) time stamp for synchronizing node clock and (ii) power management and roaming data
- **3.Transmitter switches to power-save mode after** each successful data transmission for power management periodically activating the sleep mode
- Buffering by a receiver and starting processing after enough data received in buffer also saves power

Wireless Application Protocol (WAP1.1 and 2.0) Architecture:



Figure 12.8 HTTP based web access architecture over the Internet

- Hypertext means a text which can embed the links to any other text, image, audio clip, or video clip through the URLs and hence enable navigation through these URLs
- HTTP transfers a hypertext, text, data, or voice tagged using HTML
- Similarly, WAP transfers a text written in WML (wireless markup language)
- **WAP 1.1:**
- Two sets of software
- WAE (wireless application environment)
- WAE services
- **Wireless Application Environment (WAE) 1.1**

-

WAE 1.1

- **WML(wireless mark-up language)**
- **WMLScript**
- **WBXML (WAP binary XML)**
- **WTA (wireless telephony applications)**
- **User agent profile**
- **Data formats [vCard 2.1, vCalendar 1.0, address book, pictogram, pictures (jpg, gif, ...)]**
- **Remote service provider pre-configuring of the device for provisioning the services**

- **WAE in WAP 1.1**

- **WML [Refer Lesson 5 for details]**
- **WBXML**
- **WTA**
- **WML Script**
- **Data formats— vCard 2.1, v Calendar 1.0, address book, and pictures (jpg, gif, ...)**
- **User agent**
- **WAP 1.1 provides for communication of client with gateway or proxy using WBXML**
- **XML and WML page document are not compact**
- **WBXML**
- **WAP 1.1 provides for communication of client with gateway or proxy using WBXML**
- **XML and WML page document are not compact**
- **WBXML specification in binary representation so that XML or XML-based language—transmitted and received in compact format**
- **A binary number can represent a tag in place of characters**
- **Another binary number can represent an attribute in place of characters**
- **For example, attribute ID needs two characters**
- **It is represented by a single byte**
- **Attribute title needs five characters**
- **It is also represented by a single byte**

- **Wireless Telephony Application (WTA) Protocol**
- Call set up
- call accept
- call forwarding
- caller line ID
- connected line ID
- closed user group
- multiparty groupings
- call waiting
- call barring
- operator restrictions
- call charge advice
- contacts entry in phone book
- call hold
- conferencing
- ring tones
- speed dial
- telephone/fax
- SMS up to 160 characters
- emergency number, MMS—gif, jpg, wbmp, teletext, and videotext access
- **WATI (WTA interface)**
- WATI provides the interfaces the features using WML browser
- A WTA URI can be wtai://wap.mcard: followed by a telephone number
- Identical to port number specifications provided in the URL
- **Wireless Telephony Application (WTA) Server**
- Server can push the WMLScript or deck contents
- **Wireless Telephony**
- **Application (WTA) event handler**

- A WTA event handler can handle WTA events
- Example of an event— change in data-field content
- A persistent storage interface helps in storing the data on device when the content is modified. WTA also provides security interface
- Only authorised gateway or proxy can access the data at the server
- **User Agent**
- Software used by the user to give input using VUI (voice user interface)
- GUI (graphic user interface)
- To interact with mini browser (browser with limited screen size)
- Executes the WMLScript at the client and displays the results
- Displays the WML decks received as response from the server
- Provides small screen device characteristics, font, and display capabilities
- Enhances the input capabilities, for example, the use of T9 keypad, stylus, and touch screen is enabled
- **Data formats for data displayed on a mobile device**
- vCard 2.1 is the format for visiting card
- vCalendar 1.0 is the format for calendar
- Also a mobile device provides pictogram which is a small picture of very low resolution that cannot be split and can be placed along with the text
- Pictogram used for displaying logo
- **WAP 1.1 and WAP 2.0 Protocol Layers**

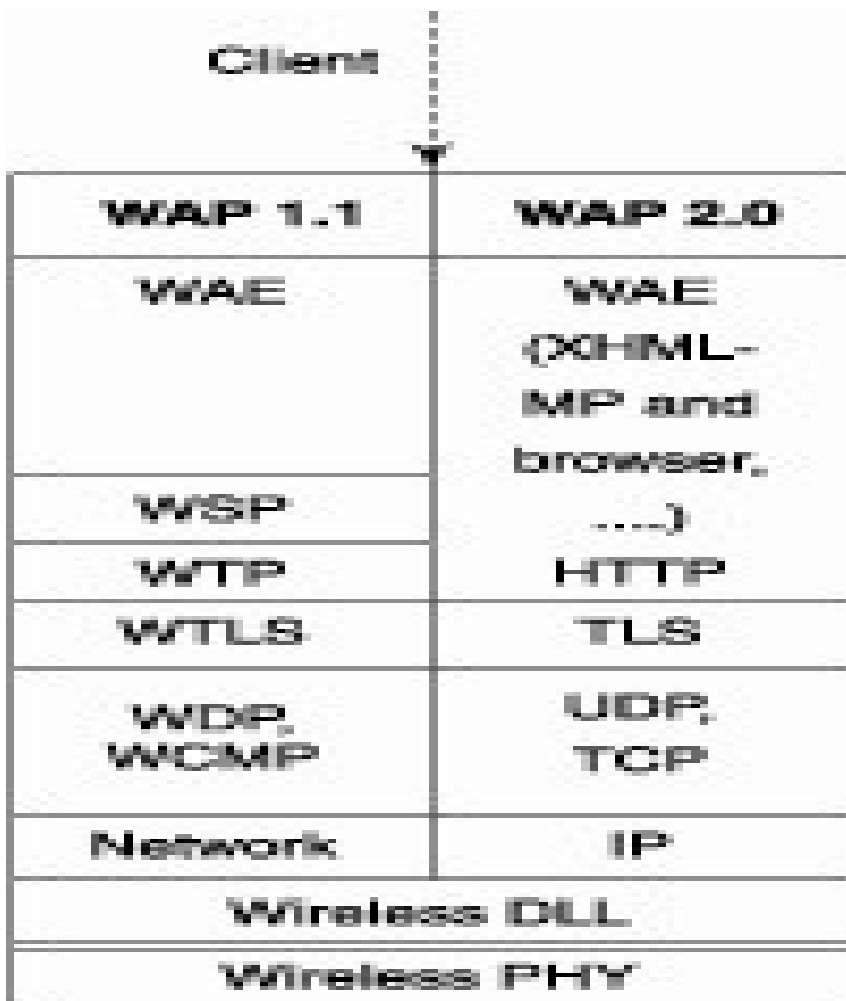

-
- Remote service provider pre-configuring of the device for provisioning of services
- Used for data synchronization between server and mobile devices

WAP 1.1 Gateway:

- Required for protocol conversions between two ends—mobile client device and HTTP server
- Required for iWMLScript (Internet WML script) compilation into CGI script which runs at the HTTP server to get HTML response which is sent to the client application
- Gateway converts WAE 1.1, WSP, WTP, WTLS, and UDP layers encoded data packets into the HTTP, TLS (in HTTPS), and UDP layers encoded data packets when the device transmits data to server
- Does decoding when the server sends data to client through the gateway
- WAP 1.1 gateway encoders and decoders not required in WAP 2.0
- A WAP gateway connects WAP client to HTTP servers
- HTTP server serves the websites on the Internet

- HTTP layer in TCP/IP protocol suite acts as application layer protocol when connecting to Internet on a wired network

Networking Layer Protocol WDP (wireless datagram protocol)

- A datagram gives independent information and is stateless
- The data of a datagram is sent by a connectionless protocol
- WDP (wireless datagram protocol) a connectionless information
- Similar to UDP in TCP/IP suite
- Used for multicasting a datagram on the network
- A header and then user data which is received from upper layers at the device
- Consists of a source port, a destination port (optional), source address (an identifier IP address or telephone number), destination address (optional), length of data, and checksum bytes for the header (to check erroneous receipt of header)
- An error-code as per the error is also reported to the upper layer, for example, in case the datagram could not reach its destination.

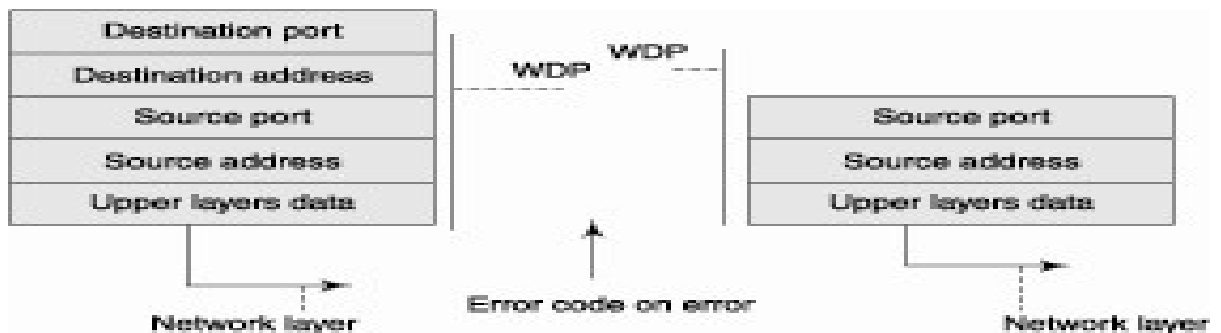

WCMP (wireless control message protocol) :

- Similar to ICMP
- WCMP employs a datagram with a WCMP header when sending the messages for querying to find information, reporting errors, making route address advertisement, and for a router seeking (soliciting) messages

Wireless Transport Layer Security (WTLS) protocol

- Data transaction occurs between client device and gateway
- Assures integrity and privacy in transactions and device authentication
- WTLS layer maps to SSL (secure socket layer) in HTTPS

- SSL is also called TLS (transport layer security)
- WTLS supports TCP (transport layer protocols), WDP, and WCOMP

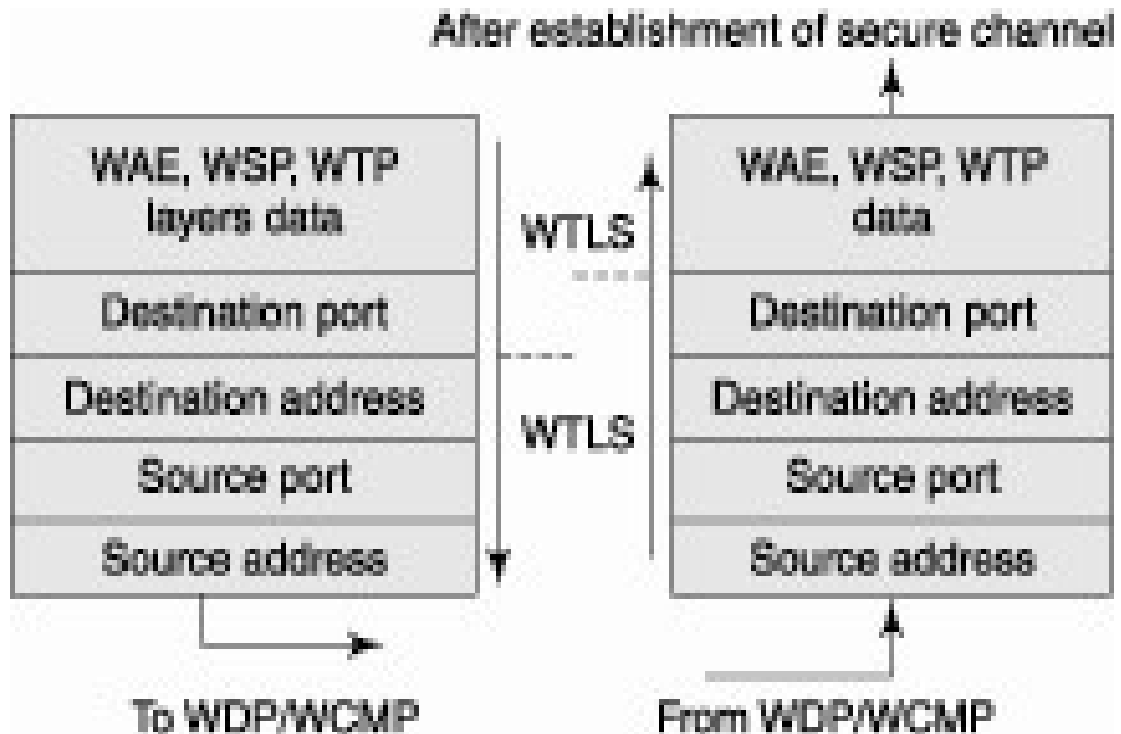

•

WTLS specifications

- **For establishment of the secure session**
- Source device messages create process:
 - source address and port
 - destination address and port
- RSA or ECC (a proposed suite of algorithms for key exchange)
- IDEA or DES (a proposed suite of algorithms for ciphering the data)
- Compression method for data compression
- Other end messages for secure channel exchange for confirmation of *create* process as follows:
 - (i) sequence number mode
 - (ii) how many times key is refreshed and exchanged again
 - (iii) identification of session after establishment of the session
 - (iv) RSA or ECC (a chosen suite of algorithms for key exchange)
 - (v) IDEA or DES (a chosen suite of algorithms for ciphering the data)

- (vi) chosen compression method for data compression
- On request from the other end, source device messages for secure channel public key authentication by a client certificate
- Source device messages to commit request
- Other end peer messages for commit confirmation request

Wireless Transaction Protocol (WTP):

- Transmits data to WTLS in case of secure transactions and directly to WDP or WCMP
- Supports joining (fusion) of the messages and enables asynchronous transactions
- Supports abortion of the transactions and provides the information about the success or failure of a transaction to the sender
- **To ensure reliability of transactions— Class 0**
- Three WTP service classes—0, 1, and 2

Class 0— a source sends the messages with no response from the other end

- **To ensure reliability of transactions— class 1**
- Source first invokes a transaction along with the request
- Device then obtains the confirmation of invocation
- Followed by the transaction for the resulting response
- The device sends the acknowledgement
- **Transactions — Class 1** removes duplicate data, provides retransmission as well as a transaction identifier
- Provides push services in which there is no acknowledgement of data by user, except that there is confirmation of invocation
- **To ensure reliability of transactions— class 2**
- Source first invokes a transaction along with the request
- Device then obtains the acknowledgement of data (through gateway or proxy) from user
- Followed by a transaction for the resulting response
- The device sends the acknowledgement
- Class 2 transaction removes duplicate data, provides retransmission as well as a transaction identifier
- Provides acknowledgement of two types— user acknowledgement and automatic acknowledgement

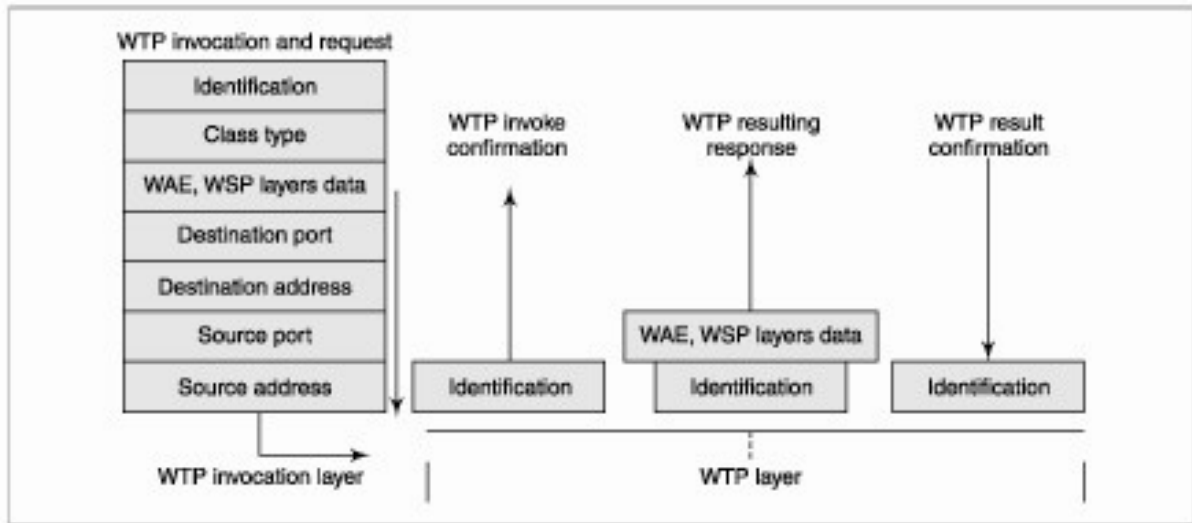

Wireless session protocol (WSP)

- Transmits data to WTP in case of thin client transactions or directly to WDP or WCOMP
- WTLS serves as a layer above WDP when a secure transfer is required for a datagram
- Like HTTP, supports stateless data transfers
- Enables a browser to get the packets from the server in any sequence
-

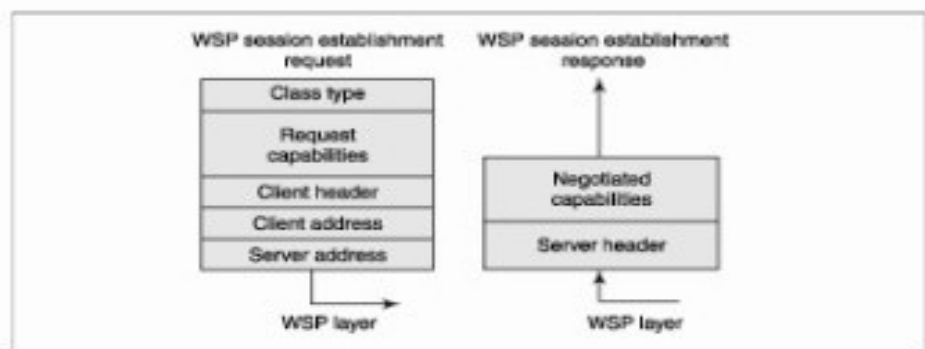
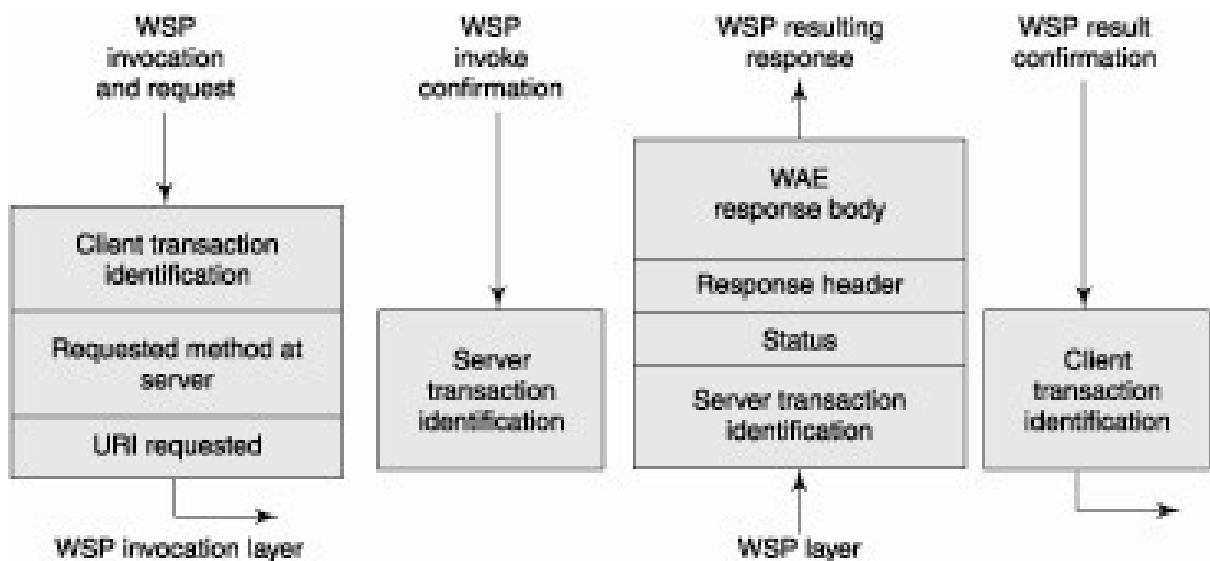

Fig. 12.9 WSP protocol session connection establishment and resulting response headers

- Also supports asynchronous exchanges
- Multiple requests

- Push and pull mechanisms of data dissemination
- Capability negotiation
- Content encoding
- Content type definitions
- WBXML (WAP binary XML)
- Possesses HTTP functionality
- **WSP session** is first established— use the functions of agreed common protocol
- An established session can be suspended and then resumed from the point at which it was suspended.
- A session can be terminated (released)
- **WSP headers when sending WSP invocation and request**
-



- Three WSP service classes
- Class 0—This class is for a source sending the unconfirmed push
- Supports session suspension, resumption, and management
- The messages sent from the source do not get any response from the other end
- Class 1—for a source sending the confirmed push
- Class 2—for a source supporting session invocation, suspension, and resumption
- **WSP header for the method invocation and request to server**

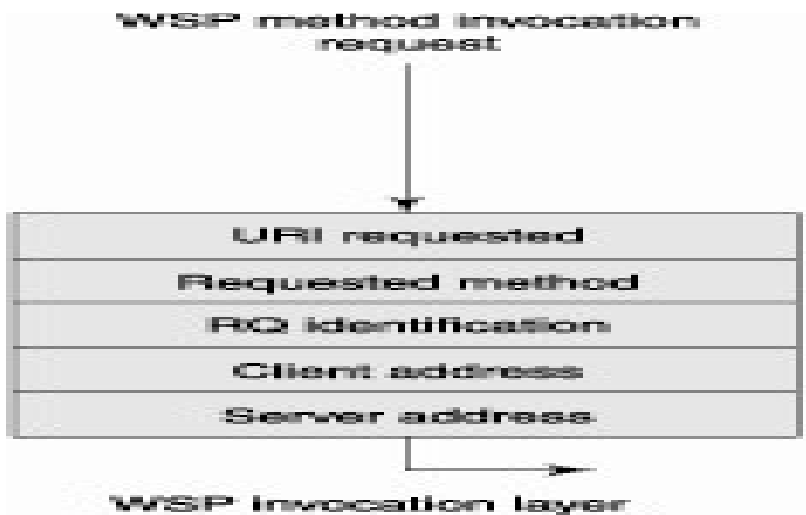

-

- **WSP header for server response**

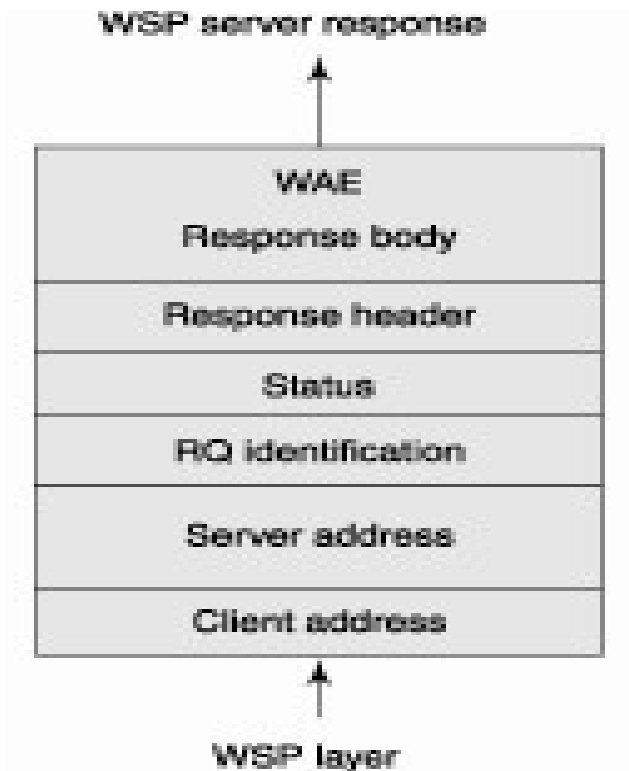

-

- **WSP header when WSP Push**

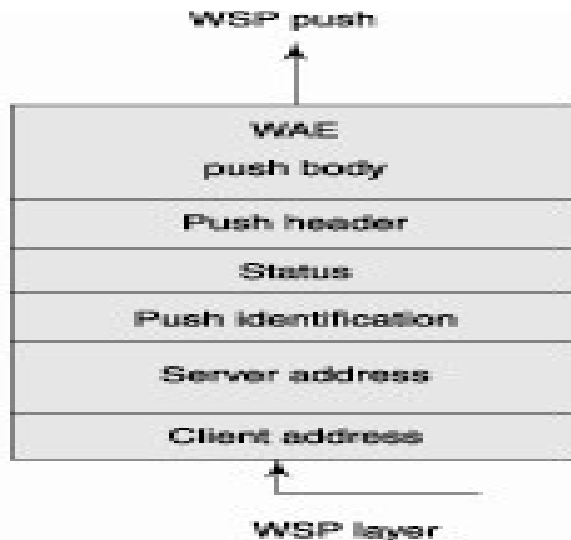

-
- The constraints of mobile devices are low computing capability and narrow bandwidth network connection with intermittent loss of connectivity
- WSP in WAE used for WAP user agent push service
- WTA events used to push the data to the device

• **Wireless Application Environment:**

WML:

- Used to create the cards for mobile application (s)
- Two versions— WML 2.x and WML 1.x
- WML 2.x includes XHTML-MP which includes XHTML
- WML 1.x does not include XHTML
- A collection of decks and cards
- A WML deck is saved in a file with extension wml
- Each file contains one deck
- For example, a welcome deck can be saved in a WML file welcome.wml
- Can have number of cards
- There is a navigational link from one card to another
- WML provides for management of the navigation between cards and decks
- **WML card** A scaled down set of procedural elements
- Used to control navigation between cards
- A card represents an interaction with the user and the deck contains the cards

- Provides the content (for example, a program, command, data, string, or image)
- Supports variety of formatting commands as well as layout commands
- Commands are defined by tags and attributes
- Provides user interface for mobile devices with constraints as mentioned in the preceding text
- Organizes similar to deck and cards
- **WML parser**
- Parses the tags, attributes, and underlying text within the tags present within the deck or card
- The parser is a part of a browser or server
- **format of a WML deck and card**
-

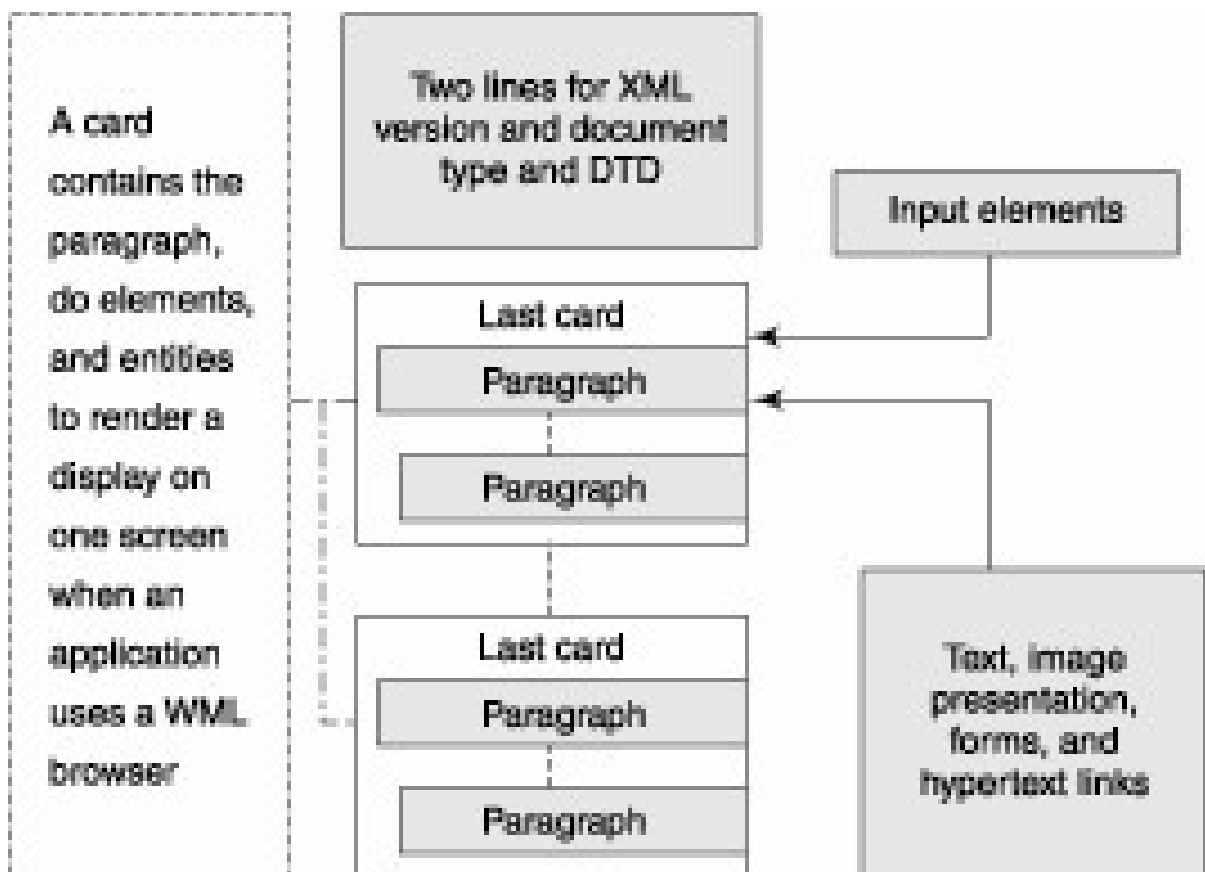

- First validated against its declared document type using WML 1.3 DTD (document type definition) before parsing

- Parsed data, information, and contents used to give input to a Java program for the application or server which runs *method(s)* at the browser or server
- Browser program runs at the client

WinWAP

- WinWAP has an Emulator which is an alternative program used for emulating the actual run at the mobile client and runs on a PC
- WinWAP is for a computing system running on PocketPC, WindowsMobile 2003, or Windows operating system

Application Running using WML Card

- A WML card containing a client-request is transmitted and response is received from server
- Element *do* is used to process the text within the do tags
- The element *label* is an attribute which defines a text, the purpose of which is simply to specify the incoming text or action

WML Script:

- A script language in which each line is loaded in computer and is executed at run time only
- There is no pre-compilation
- WMLScript in WAP is similar to JavaScript and is used for client-side scripting
- It obviates the need to communicate with the server by sending a request and waiting for the response generated by an application running at the server
- Can embed the markups in WML
- WAP browser displays the page having WML and WMLScript
- WMLScript used to open dialog box so that the user can input data or text
- Also used for generating error messages
- The execution of WML Script is fast
- **Standard Library Function— WML Br**
- Has the functions to control the WML browser or to get information from the browser
- **WMLDialogs**
- Has the functions which display the input boxes to users, also provides for alert and confirmation messages
- **WMLLang**

- WMLLang library has the core WML functions, for example, for converting a data type integer to string character
- **– WMLString**
- Has the functions that help in concatenation, truncation, picking of select portions, and manipulation or finding the length of the strings. An example is the find() function to know whether a sub-string is a part of a string
- If yes, then the function returns the index of the first character of the match in the string, otherwise it returns -1
- String.find (“09229122230”, “30”) returns 9 which is the index of first character of the match in the string
- String.find (“09229122230”, “39”) returns -1 since there is no match between sub-string characters and the string
- var strlen = String.length (“WELCOME TO ABC MOBILE) returns 21 because number of string characters are 21
- Space is also a character
- **Standard Library Function— WMLURL**
- Has functions for using relative URLs or absolute URLs for finding the port number or for testing whether a URL is valid or not. [For example, <http://www.microsoft.com/msoffice/winword/> is a relative URL
- **– WMLFloat** Has the functions that help in performing floating-point arithmetic operations in case a specific WAP device supports floating-point operations, conversions, and calculations
-